











— j”>••“č š « œ a α™ • š • “¥” ‘  
=HKL

k fZjIZ ] P\_gu mdZaZgu \ jm[eyo [\_a mq\_IZ C  
H[eZklv ijbf\_g\_gby fZ]bkljZevgu\_ b \gmljbd\ZjIZevgu\_ k\_lb ohayckl\\_ggh [ulh\h]h ijhfure\_ggh]h b  
\h^hh\\_\^\_gby Hkgh\gu\_ oZjZdl\_jbklbdb ihebf\_jguo dheh^p\_\ \ukhdZy klhcdhklv d klZlbq\_kdbf b ^  
gZ]jmadZf ]\_jf\_lbqghklv kjhd kem`[u [he\_\_ e\_l m^h[kl\h h[kem`b\Zgby rbjhdhc ^bZiZahg ih^  
qbke\_ hi\_jZlb\guo d ^\_ckl\mxs\_fm dheh^pm Dheh^pu D h[kem`b\Zxlky k \hafh`ghklvx ^hklmiZ \  
ijh]jZff\_ ihklZ\hd lZd`\_ lZg]\_gpbZevgu\_ i\_j\_iZ^gu\_ b ^h`^\_ijb\_fg\_u\_ dheh^pu

Bgki_dpbhgguc dheh^_p BD ^bZf_lj rZolu 2' ff				
Wkdba	:jlbdme	GZbf_gh\Zgb_	ljbf_qZgb_	Q`h[ sm j g kn\ `b H?L
	5318400015	Exd ihebf_jguc ^ey rZolu dheh^p	DeZkk : gZ]jmadZ RZolu : evl_jgZlb\Z l_e_ m^ebgbl_ex >ey ]ZahgZ	l Nbdkb_m_lky kdh678,00 dhfm
	5315315400	L_e_kdhibq_kdbc m^ebgbl_ev k i_j_oh^hf gZ rZolm dheh^pZ BD	DeZkk ' gZ]jmadZ exdmekjORZ_ bZy \ukhlZ ^h : evl_jgZlb\Z ihebf_jghfm ijh_a`_c qZklb	8,443,00 exdm >ey
	5312400412	RZolZ dheh^pZ BD p_gZ aZ	RZolZ ba ljm[u DHJKBK mkeh\guc ijhoh^ ff	'1,2' 1640,00
	5074000000	Miehlgl_evgh_ dhevph ff	>ey kh_^bg_gby rZolu l_e_kdhiZ ehldhf	574,00 k [Zah
	5311110030	;ZaZ BD Lbi wnn_dlb\gZy \ukhlZ [Zau ff	;ZaZ ehld lbi \uoh^ jZaf_j ih 2' ^ey jeZ^dbb_ljm[l<O	3 449,00 ž
	5311160030	;ZaZ BD Lbi wnn_dlb\gZy \ukhlZ [Zau ff	ih^kh_^bg_gb_ DHJKBK q_j_a klZg^Zjlguc i_j_oh^ DHJKBK	'_ 3 449,00 gh
	5311200030	;ZaZ BD Lbi wnn_dlb\gZy \ukhlZ [Zau ff	jeZ^dZy ljm[Z	3 449,00
	5311110234	;ZaZ BD Lbi wnn_dlb\gZy \ukhlZ [Zau ff	;ZaZ ehld lbi \uoh^ ž ž jZaf_j ih 2' ^ey jeZ^dbb_ljm[l<O	3 551,00 ^u ž
	5311160234	;ZaZ BD Lbi wnn_dlb\gZy \ukhlZ [Zau ff	l<O ih^kh_^bg_gb_ DHJKBK '_eZl_evgh q_j_a klZg^Zjlguc i_j_oh^	3 551,00
	5311200234	;ZaZ BD Lbi wnn_dlb\gZy \ukhlZ [Zau ff	DHJKBK jeZ^dZy ljm[Z	5 874,00
	4151100000	AZ]emrdZ l<O '1 2'		42,00
	4151600000	AZ]emrdZ l<O '1 2'	G_bkihevah\Zggu_ \oh^u [Zau aZdju\Zxlky aZ]emrdZfb l<O	117,00
	4152000000	AZ]emrdZ l<O '1 2'		208,50
	5312000110	J_abgh\Zy fmnIZ ^ey ih^dexq_gby dheh^pZ ff	by \ rZolm >ey ijyfh]h ih^dexq_gby jeZ^ ljm[ ih =HKL b l<O ljm[	324,00 W
	5312000160	J_abgh\Zy fmnIZ ^ey ih^dexq_gby dheh^pZ ff	ih^kh_^bg_gb_ DHJKBK q_j_a klZg^Zjlguc i_j_oh^ DHJKBK	'_e 426,00 gh
	5312000200	J_abgh\Zy fmnIZ ^ey ih^dexq_gby dheh^pZ ff	jeZ^dZy ljm[Z	506,00









Bgki_dpbgguc dheh^_p BD		^bZf_lj rZofu 2'		
Wkdba	:jlbdme	GZbf_gh\Zgb_	ljbf_qZgb_	Q`h[ sm j g kn\ `b H?L
	35368800015	Exd ihebf_jguc q_jguc	DeZkk % gZ]jmadZ	1 935,00
	35368800015	Exd ihebf_jguc a_e_guc	>bZf ff >ey ]ZahgZ	2 867,00
	35368800250	Exd dhfihablguc .,2 &	DeZkk & gZ]jmadZ =_jf_lbqguc k aZfdZfb >ey ijh_a`_c qZklb	8 672,00
	5347120630	NhjZ ^ey [_lhgbjh\Zgby	:gZeh] [_lhgghc jZa]jma \gmlj_ggbc ^bZf_lj ff	4 000,00
	5322630412	RZoIZ dheh^pZ BD p_gZ aZ	RZoIZ ba ljm[u DHJKBK mkeh\guc ijhoh^ ff	3 495,00
	5076300000	Miehlgl_evgh_ dhevph ff	>ey kh_^bg_gby rZolu l_e	1 847,00

База колодца ИК600						
	Q`h[ \[bv l gz ji_efyr`hczgc ne[b[hhi^i ]pi_ ]vpi_ kn\ `b H?L		?iq[ gh ark [fjktimije [li`_ch`hc` ]pi_ ]vpi_ kn\ `b H?L			
	5321160000	BD 2'	20 953,00	5341000160	BD 2'	4 727,50
	5321200000	BD 2'	21 303,00	5341000200	BD 2'	4 939,50
	5321226000	BD ,'	Wnn_dlb\gZy \ukhIZ [Zau ff	5341000226	BD ,'	5 152,00
	5321250000	BD 2'		5341000250	BD 2'	5 152,00
	5321315000	BD 2'	23 029,00	5341000315	BD 2'	5 761,50
	5321365000	BD ,'		5341000365	BD ,'	5 761,50
;Zahfie dlm lky ijblhdZfb gZ ijhba^Zgguo nhjfu aZdZaZ dheh^pZ IHEBIE:KLBD P_gZ g_ aZ\bkkbl hl U^h U k rZ]hf U Dhebq_kl\h ^himklbfuo ih^dexq_gbc g_ [he__ lj_o						

Wkdba	:jlbdme	GZbf_gh\Zgb_	ljbf_qZgb_	Q`h[ sm j g kn\ `b H?L
	4151100000	AZ]emrdZ l<O '1 2'		42,00
	4151600000	AZ]emrdZ l<O '1 2'	G_bkihevah\Zggu_ \oh^u [Zau aZdu\Zxlky aZ]emrdZfb l<O	117,00
	4152000000	AZ]emrdZ l<O '1 2'		208,50
	5312000110	J_abgh\Zy fmnIZ ^ey ih^dexq_gby dheh^pZ ff	>ey ijyfh]h ih^dexq_gby ljm[ ih=HKL b l<O ljm[	324,00
	5312000160	J_abgh\Zy fmnIZ ^ey ih^dexq_gby dheh^pZ ff	ih^kh_^bg_gb_ DHJKBK q_j_a_klZg^Zjlguc i_j_oh^ DHJKBK	425,00
	5312000200	J_abgh\Zy fmnIZ ^ey ih^dexq_gby dheh^pZ ff	jeZ^dZy ljm[Z	506,00

<b^ dheh^pZ \ k[hj\_

BD	BD
	
	
Klhbhklv ij^kIZ\e_ggh]h gZ ko_f_ dheh^pZ \ k[hjZbkZv ij^kIZ\e_ggh]h gZ ko_f_ dheh^pZ BD \oh^Z \uoh^ ff jm[ [_a G>K	14 208,00
Klhbhklv ij^kIZ\e_ggh]h gZ ko_f_ dheh^pZ \ k[hjZbkZv ij^kIZ\e_ggh]h gZ ko_f_ dheh^pZ BD \oh^Z \uoh^ ff jm[ [_a G>K	41 685,00

Dheh^_p D ^bZf_lj rZolu 2ff				
Wkdba	:jlb dme	GZbf_gh\Zgb_	ljbf_qZgb_	Q`h[ sm j g kn\ `b H?L
	35368800015	Exd ihebf_jguc q_jguc	DeZkk % gZ]jmadZ	1 935,00E ]dbc
	35368800015	Exd ihebf_jguc a_e_guc	>bZf ff >ey ]ZahgZ	2 867,00
	35368800250	Exd dhfihablguc .,2 &	DeZkk & gZ]jmadZ =_jf_lbguc k aZfdZfb b 8j672,00^dhc	l lbi Ly`_euc
	5347120630	NhjfZ ^ey [_lhgbjh\Zgby	:gZeh] [_lhgghc jZa]jma \gmlj_ggbc ^bZf_lj ff	hgqhc jeb lu 4 000,00
	5346120630	Dhgmki_j_oh^ D D k dj_ie_gby e_klgbpu	=hjih\bgZ dheh^pZ ^ey e_klgbpu Wnn_dlb\gZy \ukhlZ	rZolu 2' k dj_ie_gby 9 078,00 ff
	5070120001	Miehlgb_l_evgh_ dhevph ^ey rZolu D D	>ey kh ^bg_gby rZolu 2' i_j_oh^hf ]jih\bghc b kh rZolu 2' k [Zahc	k dhgmkhf 4 082,00 gby
	5342120442	RZolZ dheh^pZ D k dj_ie_gby e_klgbpu p_gZ aZ if	RZolZ ba ljm[u DHJKBK '1 2' ff mke ijhoh^ ijfb \Zyggufb dheh^dZfb e_klgbpu >ebgZ rZolu jZkq ih ^Zgguf ba nhjfu aZdZaZ k rZ]hf ff >ebgZ rZolu ^h f	61 ^ey rZol ff k 10 432,00 Z_lky
	5344002440	E_klgbpZ fh^mevgZy \ Dhgmki_j_oh^ k_dpbby \ g_dhlhju_ rZolu klmi_gb	K_dpby \ dhgmki_j_oh^ k_dpbby \ g_dhlhju_ rZolu klmi_gb	^h[Z\hgqZy 11 247,00 Z gZ
	5344003840	E_klgbpZ fh^mevgZy	K_dpby fh^mevg hc e_klgbpZ	2 264,00 klmi_g
	5344001280	E_klgbpZ fh^mevgZy ^hihegbl_evgZy k_dpbby gZy k_dpbby	gZy k_dpbby gZy k_dpbby	gZ 9 52,00_gv

### База колодца K1000 ПРО

Wnn_dlb\gh_ j_r_gb_ ijb \ukhdhf mjh\g_ ]jmg]h\uo \h^ Eblh_ ^gh k jz[jZfb `zkldh k lb klhcdhklv d \_jlb dZevghfm ^Z\e_gbx ]jmg]h\uo \h^ <hafh`ghklv Zgd_jh\db dheh^pZ d				
	Q`h[ \[bv l gz ji_efyr`hczgc ne[b[hhi^i ]pi_ ]vpi_ kn\ `b H?L		?iq] gh m k [fj k c i m i j e [li`_ch`hc` ]pi_ ] \[bn kn\ `b H?L	
		5341160000	D 2'	38 330,00
	5341200000	D 2'	38 680,00	5341000200 D 2' 4 939,50
	5341226000	D ,'	39 618,00	5341000226 D ,' 5 152,00
	5341250000	D 2'		5341000250 D 2'
	5341315000	D 2'	43 776,00	5341000315 D 2' 5 761,50
	5341365000	D ,'	44 987,00	5341000365 D ,' 6 747,00
	5341400000	D 2'		5341000400 D 2'
	5341489000	D ,'	53 583,00	5341000489 D ,' 11 482,00
	5341500000	D 2'		5341000500 D 2'
	5341605000	D ,'	58 158,00	5341000605 D ,' 17 555,50
	5341630000	D 2'		5341000630 D 2'
	5341722000	D ,'	63 683,00	5341000722 D ,' 22 155,50

### База колодца K1000 ЭКО

J_dhf_g^m_lky ijbfg_g_gb_ \ kmobo ]jmg]Zo beb ijb mjh\g_ ]jmg]h\uo \h^ g_ [he__				
	Q`h[ \[bv r[lmc s[pmv l gz ji_efyr`hczgc gZij]f]p d m ]fwphi` jikrk`_ch`hc` ]pi_ ] \[bn `b H?L		kn\ `b H?L	
		0001160000	D 2'	22 146,00
	0001200000	D 2'	22 496,00	0001000200 D 2' 4 939,50
	0001226000	D ,'	23 435,00	0001000226 D ,' 5 152,00
	0001250000	D 2'		0001000250 D 2'
	0001315000	D 2'	26 771,00	0001000315 D 2' 5 761,50
	0001365000	D ,'	27 983,00	0001000365 D ,' 6 747,00
	0001400000	D 2'		0001000400 D 2'
	0001489000	D ,'	35 678,00	0001000489 D ,' 11 482,00
	0001500000	D 2'		0001000500 D 2'
	0001605000	D ,'	40 253,00	0001000605 D ,' 17 555,50
	0001630000	D 2'		0001000630 D 2'

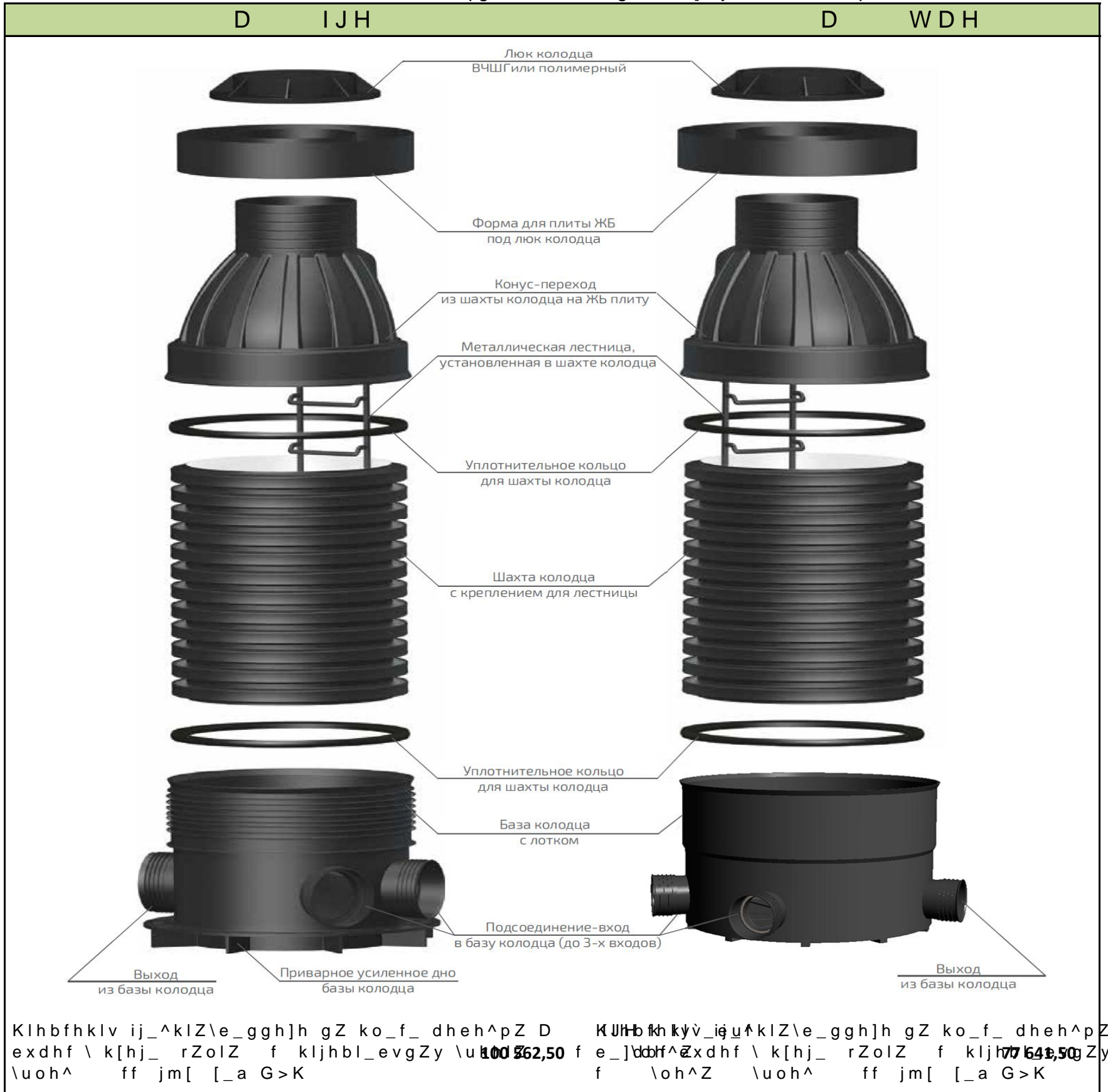

Кlhbhfklv ij\_^kIZ\^e\_ggh]h gZ ko\_f\_ dheh^pZ D K JHb fh ky^i\_u^kIZ\^e\_ggh]h gZ ko\_f\_ dheh^pZ D  
 exdhf \ k[hj\_ rZolZ f kljhb\_l\_evgZy \u100 562,50 f e\_]doh^Zxdhf \ k[hj\_ rZolZ f kljhb\_l\_evgZy \ukh  
 \uoh^ ff jm[ [\_a G>K f \oh^Z \uoh^ ff jm[ [\_a G>K

Ih^hd fhglZ`Z dheh^p\_\ ih^jh[gh hibkZg \ dZlZeh]\_ [\_agZihjguo kbkl\_f b :LJ

Nblbg]b ^ey \j_adb \ rZolm Zlfe kIZ fhglZ^Z ih^egbl_evgu_ ih^kh^bg_gby				
Wkdba	:jlbme	GZbf_gh\Zgb_	ljb_f_qZgb_	Q`h[ sm j g kn \ `b H?L
	5312000110	J_abgh\Zy fmnIZ ^ey ih^dexq_gby \ rZolm dheh^pZ ff		324,00
	5312000160	J_abgh\Zy fmnIZ ^ey ih^dexq_gby \ rZolm dheh^pZ ff	ih^dexq_gby \ rZolm	426,00
	5312000200	J_abgh\Zy fmnIZ ^ey ih^dexq_gby \ rZolm dheh^pZ ff	ih^dexq_gby \ rZolm	506,00
	5312000250	J_abgh\Zy fmnIZ ^ey ih^dexq_gby \ rZolm dheh^pZ ff	ih^dexq_gby \ rZolm	785,50
	5312000315	J_abgh\Zy fmnIZ ^ey ih^dexq_gby \ rZolm dheh^pZ ff	ih^dexq_gby \ rZolm	943,00
	35400160200	M^ebg_gguc iZljm[hd '1 2' ff k jZkljm[hf ^ey ih^dexq_gby		533,00
	35400200200	M^ebg_gguc iZljm[hd '1 2' ff k jZkljm[hf ^ey ih^dexq_gby		703,00
	35400250200	M^ebg_gguc iZljm[hd '1 2' ff k jZkljm[hf ^ey ih^dexq_gby		834,00
	35400315200	M^ebg_gguc iZljm[hd '1 2' ff k jZkljm[hf ^ey ih^dexq_gby		1079,50
	35400400200	M^ebg_gguc iZljm[hd '1 2' ff k jZkljm[hf ^ey ih^dexq_gby		1682,50
	35400500200	M^ebg_gguc iZljm[hd '1 2' ff k jZkljm[hf ^ey ih^dexq_gby		2924,50
	35400630200	M^ebg_gguc iZljm[hd '1 2' ff k jZkljm[hf ^ey ih^dexq_gby		5197,00